



BIGVENT™

TYPE-B GAS VENT IN 14" THROUGH 30" DIAMETERS

METAL-FAB BIGVENT™ WORKS FOR YOU.

What is BigVent™?

Metal-Fab BigVent is Type-B Gas Vent in 14" through 30" diameters. BigVent is factory-built, double-wall, atmospheric vent approved for Category I appliances burning natural or LP gas.

Where is it used?

It is typically used on light commercial, multi-family, loft conversions, strip centers, factories, schools, jails or other installations requiring vent diameters larger than those found in single-family houses.

BigVent is used on both new construction and rehab projects.

Is it Easy to Spec?

In addition to the quality we've built into BigVent, we offer many value-added benefits that make it extremely easy to specify.

- Complete line of components up to 30" diameter.
- Factory sizing assistance that takes the guesswork out of ordering. Just send us the plans for your project and we'll provide sizing at no charge.
- All products furnished conform to the requirements of the National Fuel Gas Code, NFPA-54.
- All products are listed to UL-441 and carry the appropriate UL mark or label.
- Warranted against defects in material or workmanship for a period of one (1) year.

Is it Easy to Order?

- Recognizing that you need product fast for your project, our large factory inventory allows us to ship within 1-3 working days of your order.
- Your order will arrive 100% complete.
- Drop shipping to the project site is available.

GET THE BIG JOBS WITH METAL-FAB BIGVENT™!

BIGVENT TYPE - B GAS VENT

Note: Vent overlaps 1.5" when joined together. Therefore, assembled length is 1.5" less than listed length.

PIPE LENGTHS - 14M through 30M

With positive twist lock on 14".

With quick connect lock using sheet metal screws on 16" - 30".

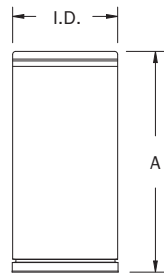

DIAMETER	12"	18"	24"	36"
14" to 30"	X	X	X	X

I.D. = 14" through 30" diameter.
A = Length. See chart for available lengths.

**ADJUSTABLE LENGTHS
M12A - M18A**

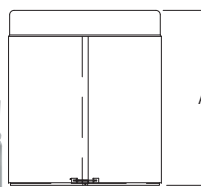

With positive twist lock on 14".

With quick connect lock using sheet metal screws on 16" - 30".

**45° 2-PIECE ELBOW - M45 - 14", 16"
45° 3-PIECE ELBOW - M45 - 18" through 30"**

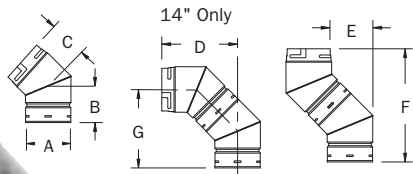

Fixed 45° 2-piece elbow shown.

16" Through 30"

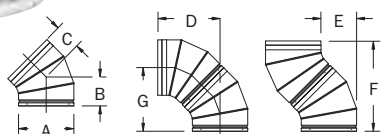

CAT. NO.	SIZE	A	B	C	D	E	F	G
14M45	14"	15.000"	8.250"	7.250"	17.25"	10.00"	25.38"	18.15"
16M45	16"	17.000"	7.000"	9.000"	19.43"	10.43"	26.43"	17.25"
18M45	18"	19.125"	10.790"	10.790"	24.99"	14.20"	35.78"	24.99"
20M45	20"	21.125"	10.790"	10.790"	24.99"	14.20"	35.78"	24.99"
22M45	22"	23.125"	10.790"	10.790"	24.99"	14.20"	35.78"	24.99"
24M45	24"	25.125"	10.790"	10.790"	24.99"	14.20"	35.78"	24.99"
26M45	26"	27.125"	11.950"	11.950"	27.78"	15.84"	39.72"	27.78"
28M45	28"	29.125"	11.950"	11.950"	27.78"	15.84"	39.72"	27.78"
30M45	30"	31.125"	11.950"	11.950"	27.78"	15.84"	39.72"	27.78"

Note: 14" elbows are adjustable, and have positive twist lock. Fixed angles in 16" through 30" diameter have quick connect lock using sheet metal screws.

BIGVENT TYPE - B GAS VENT

STANDARD TEE – MT - 14" through 30"

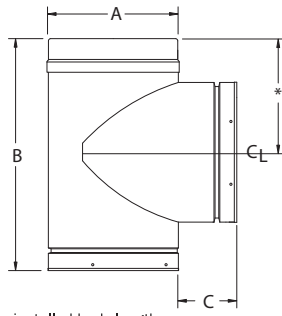

*Tap centered on installed body length

CAT. NO.	SIZE	A	B	C
14MT	14"	15.000"	23.00"	4"
16MT	16"	17.125"	28.50"	4"
18MT	18"	19.125"	30.50"	4"
20MT	20"	21.125"	32.50"	4"
22MT	22"	23.125"	34.50"	4"
24MT	24"	25.125"	36.50"	4"
26MT	26"	27.125"	38.50"	4"
28MT	28"	29.125"	40.50"	4"
30MT	30"	31.125"	42.50"	4"

Tees in 14" diameter have positive twist lock.
Tees in 16" through 30" diameter use quick connect lock using sheet metal screws.

VENT CAP – MC - 14" through 30"

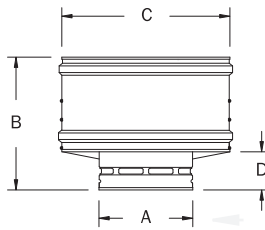

CAT. NO.	SIZE	A	B	C	D
14MC	14"	15"	23.25"	28.62"	5.62"
16MC	16"	17"	22.50"	30.62"	7.00"
18MC	18"	19"	24.50"	32.87"	7.00"
20MC	20"	21"	29.00"	39.00"	5.75"
22MC	22"	23"	29.50"	41.50"	8.00"
24MC	24"	25"	31.50"	43.50"	8.00"
26MC	26"	27"	35.50"	50.25"	6.00"
28MC	28"	29"	36.50"	52.25"	7.50"
30MC	30"	31"	37.00"	54.25"	7.50"

Note: 14" has positive twist lock.
16" - 30" has quick connect lock.

INCREASERS – Mix

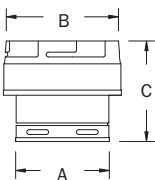

14" Only

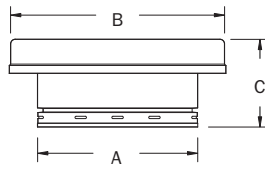

16" through 30"

CAT. NO.	14"-30"		
	A	B	C
?Mix14	Specified	x 14"	8.5"
?Mix16	Specified	x 16"	8.5"
?Mix18	Specified	x 18"	8.5"
?Mix20	Specified	x 20"	8.5"
?Mix22	Specified	x 22"	8.5"
?Mix24	Specified	x 24"	8.5"
?Mix26	Specified	x 26"	8.5"
?Mix28	Specified	x 28"	8.5"
?Mix30	Specified	x 30"	8.5"

BIGVENT TYPE - B GAS VENT

DRAFTHOOD CONNECTOR – MDC

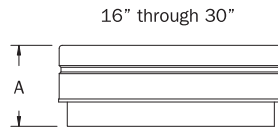
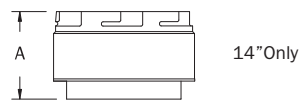

CAT. NO.	SIZE	A
14MDC	14"	4.875"
16MDC	16"	5.000"
18MDC	18"	5.000"
20MDC	20"	5.000"
22MDC	22"	5.000"
24MDC	24"	5.000"
26MDC	26"	5.000"
28MDC	28"	5.000"
30MDC	30"	5.000"

SUPPORT PLATE – MSP

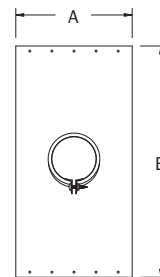

CAT. NO.	SIZE	A	B
14MSP	14"	19.5"	21.5"
16MSP	16"	21.5"	21.5"
18MSP	18"	23.5"	24.0"
20MSP	20"	25.5"	30.0"
22MSP	22"	27.5"	30.0"
24MSP	24"	29.5"	30.0"
26MSP	26"	31.5"	36.0"
28MSP	28"	33.5"	36.0"
30MSP	30"	35.0"	36.0"

HEAVY SUPPORT – MHS - 14" through 30"

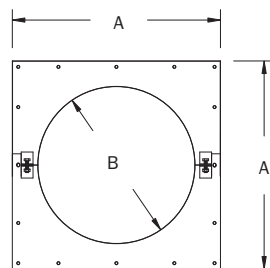
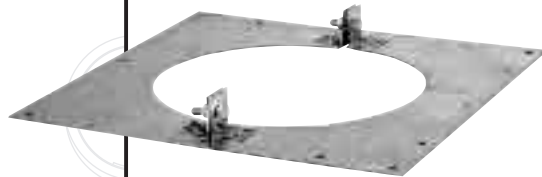

CAT. NO.	SIZE	A	B
14MHS	14"	20"	14.625"
16MHS	16"	22"	16.625"
18MHS	18"	24"	18.625"
20MHS	20"	26"	20.625"
22MHS	22"	28"	22.625"
24MHS	24"	30"	24.625"
26MHS	26"	32"	26.625"
28MHS	28"	34"	28.625"
30MHS	30"	36"	30.625"

Designed to support large size pipe sections.
Also serves as a firestop.

BIGVENT TYPE - B GAS VENT

GUY RING – MGR

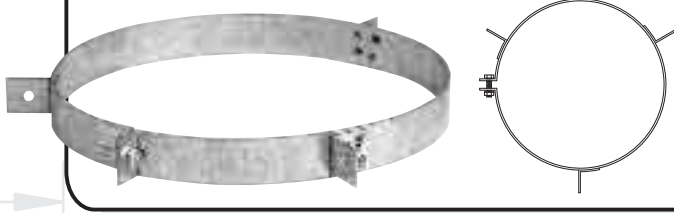

Sizes 14" through 30"
For additional support above the roof.

STANDARD FLASHING – MF

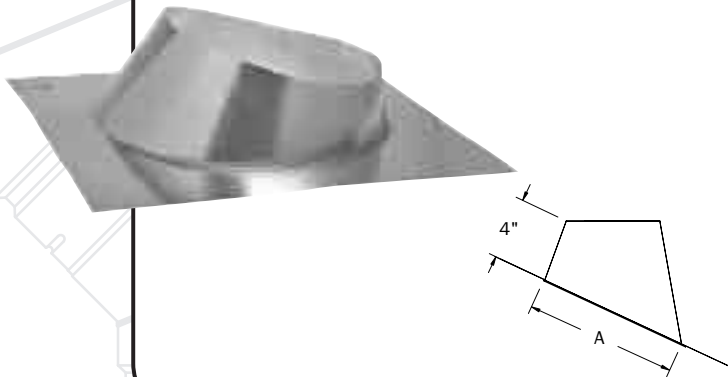

CAT. NO.	SIZE	A	PLATE
14MF	14"	18.750"	26.750" x 26.750"
16MF	16"	21.000"	29" x 29"
18MF	18"	22.750"	32" x 32"
20MF	20"	27.000"	33" x 33"
22MF	22"	26.750"	35" x 35"
24MF	24"	29.250"	38" x 38"
26MF	26"	31.750"	40" x 40"
28MF	28"	32.750"	42" x 42"
30MF	30"	36.250"	45" x 45"

Fits roof pitch from 2/12 to 5/12.

TALL CONE FLAT FLASHING – MFT

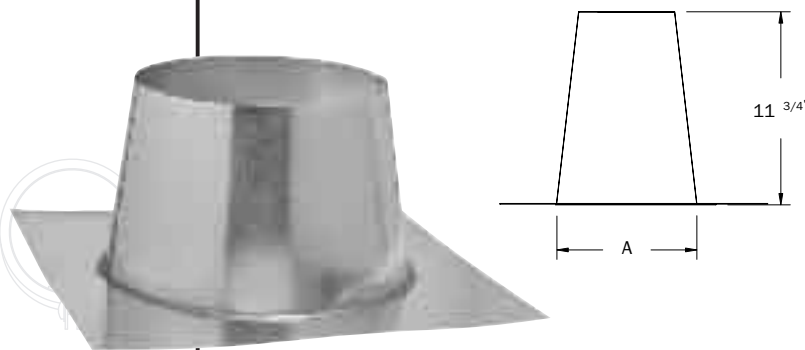

CAT. NO.	SIZE	A	PLATE
14MFT	14"	19.00"	26.750" x 26.750"
16MFT	16"	21.312"	29" x 29"
18MFT	18"	22.562"	32" x 32"
20MFT	20"	24.750"	33" x 33"
22MFT	22"	26.750"	35" x 35"
24MFT	24"	28.750"	38" x 38"
26MFT	26"	30.750"	40" x 40"
28MFT	28"	33.875"	42" x 42"
30MFT	30"	34.750"	45" x 45"

Flat roof flashing.

BIGVENT TYPE - B GAS VENT

TEE CAP – MTC



Sizes 14" through 30".
Use to cap flue when tee has no bottom (inlet) entry.

STORM COLLAR – MSC

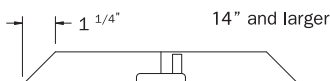

CAT. NO.	SIZE
14MSC	14"
16MSC	16"
18MSC	18"
20MSC	20"
22MSC	22"
24MSC	24"
26MSC	26"
28MSC	28"
30MSC	30"

FOR YOUR REFERENCE



Listed 441

MODEL "M" TYPE B, GAS VENT

METAL-FAB ROUND TYPE-B GAS VENT IS LISTED BY UNDERWRITERS LABORATORIES, INC. FOR USE WITH APPROVED GAS FURNACES, HEATERS AND BOILERS. METAL-FAB MEETS OR EXCEEDS ALL RECOGNIZED GAS VENTING CODES, STANDARDS OR REQUIREMENTS, WHETHER LOCAL, STATE OR U.S. MAXIMUM TEMPERATURE RATING FOR B-VENT IS 530° F.

1" Minimum clearance to combustibles for 14" through 24" diameters.
2" Minimum clearance to combustibles for 26" through 30" diameters.

A FULL LINE OF QUALITY PRODUCTS

TYPE-B GAS VENT



Easiest installation on the market...featuring SureLock™ B-Vent Locking System.

HEARTH PRODUCTS



Complete line of Solid Fuel Chimney, Pellet Chimney and Black Pipe.

CORR/GUARD™



Designed for corrosive appliances and exhaust systems.

FLEXIBLE CHIMNEY LINERS



Available in complete relining kits.

DAMPERS



Complete line of fire and ceiling radiation dampers. Capacity to fill high volume orders 100%.

DIAMONDBACK™



Flexible Gas Piping - Faster installations of gas pipe for new construction or retrofit projects.

METAL-FAB[®] INC.

P.O. BOX 1138 • WICHITA, KANSAS 67201

(316) 943-2351 • FAX (316) 943-2717

e-mail: info@metal-fabinc.com • www.metal-fabinc.com

800-835-2830